

FISH TAPE & ACCESSORY

L04 Series - Professional Fish Tape / Wire Guide

Made of high tensile & durable POM plastic

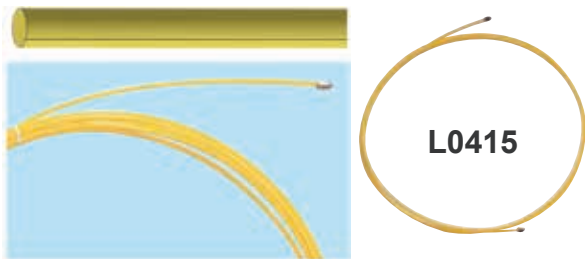

Model No.	Dia. of Wire	Length (m)	Safety Load	Breaking Strength	IN/OUT (ctn)
L0405	4.5mm	5	80kgs	135kgs	100
L0410	4.5mm	10	80kgs	135kgs	80
L0415	4.5mm	15	80kgs	135kgs	70
L0420	4.5mm	20	80kgs	135kgs	60
L0430	4.5mm	30	80kgs	135kgs	50
L0450	4.5mm	50	80kgs	135kgs	30

L05 Series - Professional Fish Tape / Wire Guide

Made of high tensile & durable POM plastic

Special made with Dia. 1.6mm wire rope coated with POM plastic



Model No.	Dia. of Wire	Length (m)	Safety Load	Breaking Strength	IN/OUT (ctn)
L0510	5.5mm	10	250kgs	400kgs	60
L0515	5.5mm	15	250kgs	400kgs	50
L0530	5.5mm	30	250kgs	400kgs	30
L0550	5.5mm	50	250kgs	400kgs	20

L07 Series - Professional Fish Tape / Wire Guide

Three ply fish tape(Black+Yellow)



2 black Dia. 2.8mm tapes and 1 yellow Dia 3.3mm tape

Model No.	Dia. of Wire	Length (m)	Safety Load	Breaking Strength	IN/OUT (ctn)	
L0710	7mm	10	500kgs	850kgs	50	
L0715	7mm	15	500kgs	850kgs	35	
L0730	7mm	30	500kgs	850kgs	20	
L0750	7mm	50	500kgs	850kgs	15	
L07100	7mm	100	500kgs	850kgs	10	
L0730T	7mm	30	With Tube	500kgs	850kgs	15
L0750T	7mm	50	With Tube	500kgs	850kgs	10

L06S Series

Professional Fish Tape / Wire Guide

Three ply fish tape(Black+Red)



2 black Dia. 2.5mm tapes and 1 red Dia 3.1mm tape

Model No.	Dia. of Wire	Length (m)	Safety Load	Breaking Strength	IN/OUT (ctn)	
L06S10	6mm	10	420kgs	700kgs	40	
L06S15	6mm	15	420kgs	700kgs	30	
L06S30	6mm	30	420kgs	700kgs	20	
L06S50	6mm	50	420kgs	700kgs	12	
L06S100	6mm	100	420kgs	700kgs	7	
L06S30T	6mm	30	With Tube	420kgs	700kgs	15
L06S50T	6mm	50	With Tube	420kgs	700kgs	10



L0450

L0550

W0850



L0650

L0750

W08 Series - Professional Fish Tape / Wire Guide

Three ply fish tape (Red+Yellow)
Special made with Dia. 1.2mm steel wire rope coated with composite material pullers

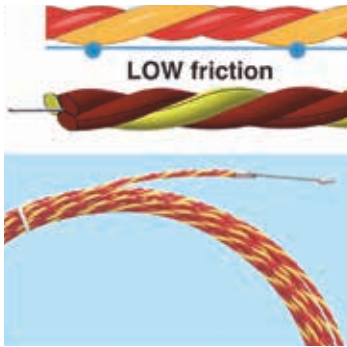

W0815

2 red Dia. 2.8mm tapes and 1 yellow Dia 3.3mm tape and 1 steel wire Dia. 1.2mm

Model No.	Dia. of Wire	Length (m)	Safety Load	Breaking Strength	IN/OUT (ctn)	
W0810	7mm	10	650kgs	950kgs	50	
W0815	7mm	15	650kgs	950kgs	35	
W0830	7mm	30	650kgs	950kgs	20	
W0850	7mm	50	650kgs	950kgs	15	
W08100	7mm	100	650kgs	950kgs	10	
W0830T	7mm	30	With Tube	650kgs	950kgs	15
W0850T	7mm	50	With Tube	650kgs	950kgs	10

L06 Series - Professional Fish Tape / Wire Guide

Three ply fish tape (Black)



L0615

3 black Dia. 2.7mm tapes

6 / 8 / 10 / 12 / 14M
16 / 18 / 20 / 22 / 24M

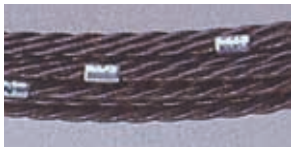

Model No.	Dia. of Wire	Length (m)	Safety Load	Breaking Strength	IN/OUT (ctn)	
L0610	6mm	10	400kgs	650kgs	50	
L0615	6mm	15	400kgs	650kgs	40	
L0630	6mm	30	400kgs	650kgs	25	
L0650	6mm	50	400kgs	650kgs	18	
L06100	6mm	100	400kgs	650kgs	10	
L0630T	6mm	30	With Tube	400kgs	650kgs	15
L0650T	6mm	50	With Tube	400kgs	650kgs	10
L0630M	6mm	30	With yard stick meter	400kgs	650kgs	10



Quick Cable Tights

Accessory of fish tape which can shorten your working time

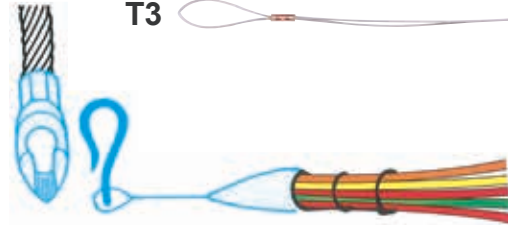

Model No.	Safety Load	Application Range
T2	120kgs	Tube 3/4" to 1-1/2"
T3	120kgs	Tube 1/2" to 3/4"

Storage Tube



T30



T50

Model No.	Tube Dia.	Dia. of Outline
T30	46mm	580mm
T50	57mm	610mm



L0750T



W0850T



L06S50T



W0450T

FISH TAPE & ACCESSORY

W03 Series

Professional Fish Tape / Wire Guide

A strongest wire guide with fluorescent color
Made of single composite material pullers

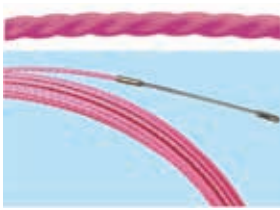

W0315

Model No.	Dia. of Wire	Length (m)	Safety Load	Breaking Strength	IN/OUT (ctn)
W0310	4mm	10	260kgs	300kgs	80
W0315	4mm	15	260kgs	300kgs	60
W0320	4mm	20	260kgs	300kgs	50
W0330	4mm	30	260kgs	300kgs	40

W04 Series

Professional Fish Tape / Wire Guide

A strongest wire guide with fluorescent color
Made of single composite material pullers



W0415

Model No.	Dia. of Wire	Length (m)	Safety Load	Breaking Strength	IN/OUT (ctn)	
W0415	4.5mm	15	300kgs	350kgs	50	
W0430	4.5mm	30	300kgs	350kgs	30	
W0450	4.5mm	50	300kgs	350kgs	20	
W04100	4.5mm	100	300kgs	350kgs	8	
W0430T	4.5mm	30	With Tube	300kgs	350kgs	14
W0450T	4.5mm	50	With Tube	300kgs	350kgs	10

W05 Series

Professional Fish Tape / Wire Guide

A strongest wire guide with fluorescent color
Made of single composite material pullers



W0515

Model No.	Dia. of Wire	Length (m)	Safety Load	Breaking Strength	IN/OUT (ctn)	
W0515	5.2mm	15	400kgs	450kgs	40	
W0530	5.2mm	30	400kgs	450kgs	25	
W0550	5.2mm	50	400kgs	450kgs	15	
W05100	5.2mm	100	400kgs	450kgs	8	
W0530T	5.2mm	30	With Tube	400kgs	450kgs	14
W0550T	5.2mm	50	With Tube	400kgs	450kgs	10

W06 Series

Professional Fish Tape / Wire Guide

A strongest wire guide with fluorescent color
Made of single composite material pullers

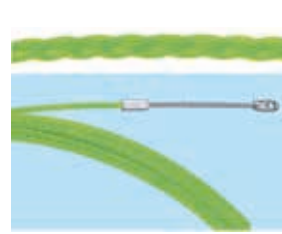

W0615

Model No.	Dia. of Wire	Length (m)	Safety Load	Breaking Strength	IN/OUT (ctn)	
W0615	6.2mm	15	500kgs	550kgs	30	
W0630	6.2mm	30	500kgs	550kgs	20	
W0650	6.2mm	50	500kgs	550kgs	12	
W06100	6.2mm	100	500kgs	550kgs	8	
W0630T	6.2mm	30	With Tube	500kgs	550kgs	14
W0650T	6.2mm	50	With Tube	500kgs	550kgs	10

Pull Handle

Safer and faster

Protect your hand with soft pull Handle



Model No.	Dia. (mm)	Thickness (mm)	Color Choice
PH-2	75	10	Grass Green & Light Orange & Dark Black

Nylon Fish Tape N-Series

High quality nylon material
One end with flexible pilot spring & one end with firm pulling unit



Exchangeable Head

Nylon Fish Tape NP-Series

High quality nylon material
Both ends with firm pulling units



Exchangeable Head

FISH TAPE SERIES

Fixed Type				Fixed Type				Fixed Type			
Model No.	Diameter	Length	Safety Load	Model No.	Diameter	Length	Safety Load	Model No.	Diameter	Length	Safety Load
N0405	4mm	5m	300kgs	N0405P	4mm	5m	300kgs	N0405S	4mm	5m	300kgs
N0410		10m		N0410P		10m		N0410S		10m	
N0415		15m		N0415P		15m		N0415S		15m	
N0420		20m		N0420P		20m		N0420S		20m	
N0425		25m		N0425P		25m		N0425S		25m	
N0430		30m		N0430P		30m		N0430S		30m	
N0305	3mm	5m	220kgs	N0305P	3mm	5m	220kgs	N0305S	3mm	5m	220kgs
N0310		10m		N0310P		10m		N0310S		10m	
N0315		15m		N0315P		15m		N0315S		15m	
N0320		20m		N0320P		20m		N0320S		20m	
N0325		25m		N0325P		25m		N0325S		25m	
N0330		30m		N0330P		30m		N0330S		30m	

Exchangeable Type				Exchangeable Type				Exchangeable Type			
Model No.	Diameter	Length	Safety Load	Model No.	Diameter	Length	Safety Load	Model No.	Diameter	Length	Safety Load
N0405C	4mm	5m	300kgs	N0405PC	4mm	5m	300kgs	N0405SC	4mm	5m	300kgs
N0410C		10m		N0410PC		10m		N0410SC		10m	
N0415C		15m		N0415PC		15m		N0415SC		15m	
N0420C		20m		N0420PC		20m		N0420SC		20m	
N0425C		25m		N0425PC		25m		N0425SC		25m	
N0430C		30m		N0430PC		30m		N0430SC		30m	
N0305C	3mm	5m	220kgs	N0305PC	3mm	5m	220kgs	N0305SC	3mm	5m	220kgs
N0310C		10m		N0310PC		10m		N0310SC		10m	
N0315C		15m		N0315PC		15m		N0315SC		15m	
N0320C		20m		N0320PC		20m		N0320SC		20m	
N0325C		25m		N0325PC		25m		N0325SC		25m	
N0330C		30m		N0330PC		30m		N0330SC		30m	

Operation View

How to pull the wire with nylon fish tapes?

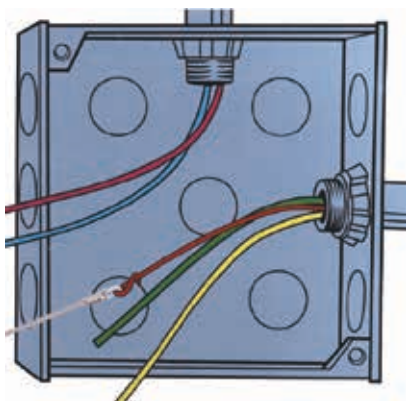

Nylon Fish Tape NS-Series

High quality nylon material
Both ends with flexible pilot springs



Exchangeable Head

FISH TAPE & ACCESSORY

BW Series

Professional Fish Tape / Wire Guide

Rattlesnake fish tape with leader & case
 Filate-line-tube & complicated bent line can easy go through
 Large Handle increases stability for better winding control



BW0530



BW0430



BW0330

BETTER SECTION OF FISH TAPE

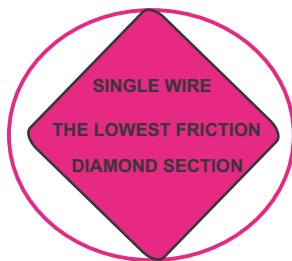

BW0415

BW0515

Model No.	Dia. of Wire		Length (m)	Weight (kg)	Safety Load	Breaking Strength	IN/OUT (ctn)
BW0315	4mm		15	1.2	260kgs	300kgs	5
BW0330			30	1.5			5
BW0345			45	1.8			5
BW0360			60	2			5
BW0415	4.5mm		15	1.2	300kgs	400kgs	5
BW0430			30	1.5			5
BW0445			45	1.8			5
BW0460			60	2			5
BW0515	5.2mm		15	1.3	400kgs	450kgs	5
BW0530			30	1.7			5
BW0545			45	2.1			5
BW0560			60	2.5			5

AF & BF Series

Professional Fish Tape / Wire Guide

Fiberglass fish tape with leader & case
 Suitable for telecommunication installation
 Smooth tape surface & it does not scrape the user
 Large Handle increases stability for better winding control

AF-15

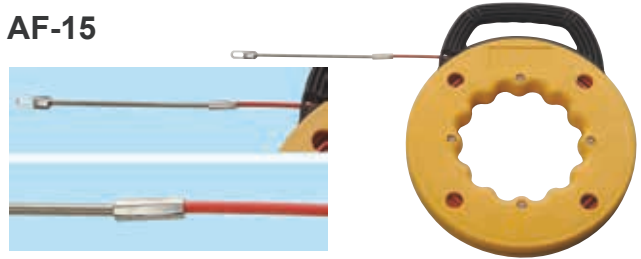

BF-30

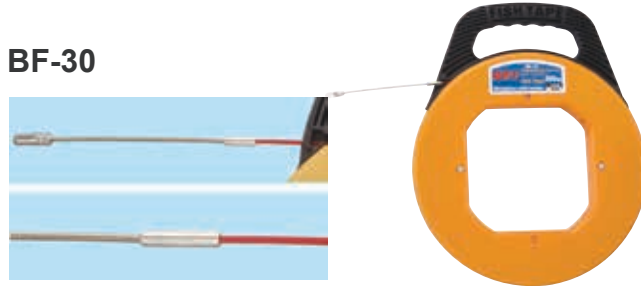

Model No.	Tape WxH		Length (m)	Weight (kg)	Safety Load	Breaking Strength	IN/OUT (ctn)
AF-15			15	0.52	280kgs	330kgs	10
BF-15			15	1.02			5
BF-30	3.7x2.8 mm		30	1.26			5
BF-45			45	1.46			5
BF-60			60	1.6			5
BF-80			80	1.8			5

AS & BS Series

Professional Fish Tape / Wire Guide

Steel fish tape made of flexible spring steel & blue finished
 With durable plastic container & slide Handle
 Easy to thread the pipe & pull out the electric cable

AS-15

BS-30

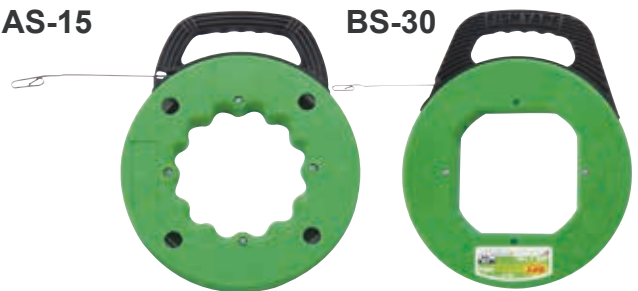

Model No.	Tape WxH		Length (m)	Weight (kg)	IN/OUT (ctn)
AS-15			15	0.9	10
BS-15			15	1.1	5
BS-18	3.2x1.6 mm		18	1.3	5
BS-30			30	1.9	5
BS-45			45	2.4	5
BS-60			60	3	5
BS-73	405mm		73	3.4	5
BS-73B			73	3.8	5

FISH TAPE SERIES

View of different kinds fish tape with case: BW & BF & BS Series

Different material, different length
Fish tape with easy-carrying case
With smooth Handle



BW0445
BW0460

BW0545
BW0560

BF-15
BF-30
BF-45
BF-60
BF-80

BW0515
BW0530

BW0415
BW0430

BS-15
BS-18
BS-30
BS-45
BS-60
BS-73

View of different kinds fish tape with storage tube: T-Type Series

Different material, different length
Fish tape with storage tube, which can be shouldered while working

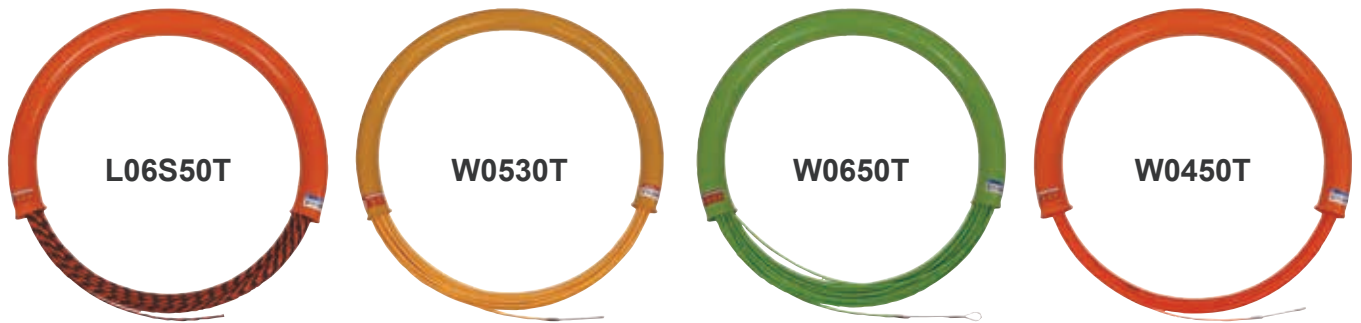

L06S50T

W0530T

W0650T

W0450T

FISH TAPE SERIES

Polyethylene Line Guard / Overhead Line Guard

Protect you from electric shock of high voltage

PL-3M



W0530T

With OPT standard packing

Model No.	Voltage Proof	Inside Dimension	Length
PL-3M	AC 20kV/3 Min.	35mm	3m

FISH TAPE & ACCESSORY

Fish Tape with T60 Frame

Small, exquisite & easy for carrying
New OPT option for the frame
Smooth rolling

Special anti-rust treatment for the frame, great protection and more durable
Multiple choice for the fish tape
Small, light & easy operation

W08100T



W06100T



L06100T



F06100T



FRP+AAS



T60 Frame

Special anti-rust treatment for the frame
Great protection and more durable

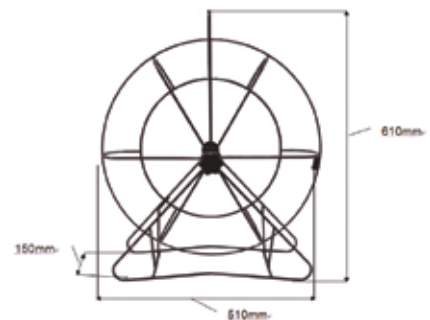

Model No.	Dia. (mm)	Weight (kg)	Dimension (mm)
T60	520	2.24	510(L)x150(W)x610(H)

Model No.	Dia. (mm)	Description	Breaking Strength	Length (m)	Weight (kg)
F06100T	6	FRP Tape (Yellow)	650kgs	100	4.8
F06150T	6	FRP Tape (Yellow)	650kgs	150	7.2
L06100T	6	Three-Ply Tape (Black)	650kgs	100	6
L06150T	6	Three-Ply Tape (Black)	650kgs	150	7.7
L06S100T	6	Three-Ply Tape (Black+Red)	650kgs	100	6
L06S150T	6	Three-Ply Tape (Black+Red)	650kgs	150	7.7
L07100T	7	Three-Ply Tape (Black+Yellow)	850kgs	100	6.5
L07150T	7	Three-Ply Tape (Black+Yellow)	850kgs	150	8.5
W04100T	4.5	Single-Composite Tape (Orange)	300kgs	100	4.3
W04200T	4.5	Single-Composite Tape (Orange)	300kgs	200	5.2
W05100T	5.2	Single-Composite Tape (Yellow)	420kgs	100	4.7
W05200T	5.2	Single-Composite Tape (Yellow)	420kgs	200	6.9
W06100T	6.2	Single-Composite Tape (Green)	550kgs	100	5.5
W06150T	6.2	Single-Composite Tape (Green)	550kgs	150	8.5
W08100T	7	Three-Ply Tape (Red+Yellow)	950kgs	100	7
W08150T	7	<i>Low Friction: Steel Wire Rope+Composite Tape</i>	950kgs	150	9.2

Heavy Duty Frame



T300

T200

T100

Model No.	Dia. (mm)	Weight (kg)	Dimension (mm)
T100	1000	25	1000(L)x500(W)x1200(H)
T200	1200	31	1200(L)x500(W)x1400(H)
T300	1400	38	1400(L)x500(W)x1600(H)

Fish Tape with T100/T200/T300 Heavy Duty Frame

Big frame for outside & construction site use



F14200T

F11200T

F09200T

Model No.	Dia. (mm)	Description	Breaking Strength	Length (m)	Weight (kg)
F09100T	9	FRP Tape (Orange)	1250kgf	100	41
F09200T	9	FRP Tape (Orange)	1250kgf	200	51
F11100T	11	FRP Tape (Orange)	1680kgf	100	48
F11200T	11	FRP Tape (Orange)	1680kgf	200	66
F14100T	14	FRP Tape (Orange)	2800kgf	100	64
F14200T	14	FRP Tape (Orange)	2800kgf	200	88

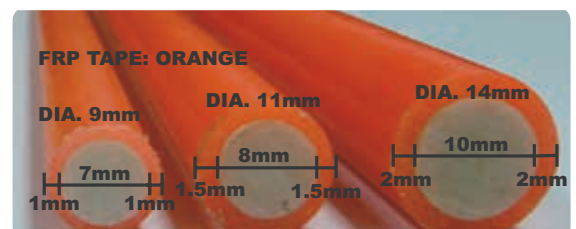

FRP+AAS

FISH TAPE SERIES

Section Fish Rods Kits

For gaining access to wires & cables under floorboards, above ceiling, trunking and wall cavities

Connect individual sections end-to-end to create a variety of lengths

Threaded connectors are beveled on both ends to prevent snagging & hang ups on obstructions

Packaged with a carrier tube, easy for carrying and holding



FS5100T
FS6100T
WS5100T
WS6100T

FS533T
FS633T
WS533T
WS633T



Model No.	Dia. (mm)	Tape Material	Length & Section Quantity	Color
FS533T	5.2	FRP Fiberglass Reinforced Plastics	10 pcs 33cm sticks	Yellow
FS5100T			10pcs 1m sticks	
FS633T	6	FRP Fiberglass Reinforced Plastics	10 pcs 33cm sticks	Yellow
FS6100T			10pcs 1m sticks	
WS533T	5.2	Single Composite Material	10 pcs 33cm sticks	Light Yellow
WS5100T			10pcs 1m sticks	
WS633T	6.2		10 pcs 33cm sticks	Light Green
WS6100T			10pcs 1m sticks	

10 pieces 1m sticks **10 pieces 33cm sticks**
Total Length 10m **Total Length 330cm**

+Accessories are for optional purchasing

Accessories for Section Fish Rods Kits

Different accessories for different applications and customization is welcome

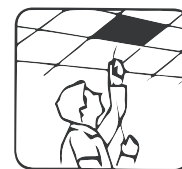

Ceiling Ducts

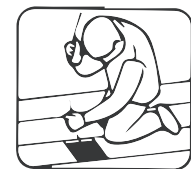

Under Floorboards



Wall Cavities

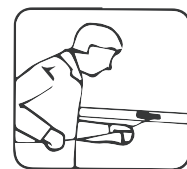

Trunking

Model No.	Description
FS6-1	Ring
FS6-2	Cable Tight Extender
FS6-3	Hock
FS6-4	Circle Ring
WS5-1/WS6-1	Ring
WS5-2/WS6-2	Cable Tight Extender
WS5-3/WS6-3	Hock
WS5-4/WS6-4	Circle Ring



② **Cable Tight Extender**



① **Ring**



③ **Hock**



④ **Circle Ring**

FISH TAPE & ACCESSORY

Tube Obstacle Checking Tool

Detect the obstruction of wire exactly
Detect the trend of tube for avoiding drilling the tube

- EW-20
- EW-30
- EW-50



Model No.	Length (m)	Detect Capacity
EW-20	20	Metal tube thickness less than 4mm Plastic tube thickness less than 6mm Cement ground Max. thickness 280mm
EW-30	30	
EW-50	50	

GC-1



GC-2



Model No.	Description
GC-1	Tube Obstacle Checking Tool
GC-2	Tube Obstacle Checking Tool

Cement Filling Tool

Fill the gaps of building as below

- + Gaps between windows
- + Door frame with wall
- + Holes between the pipe and wall
- + Connect two concrete blocks
- + Filling between two acoustic Celotex board
- + Filling between way and drive way

CEM-1



CEM-2



CEM-3



Model No.	Diameter (mm)	Length of Tube(mm)	Length (mm)	Weight (kg)	Volume	Cup	Outlet (mm)
CEM-1	61	425	650	0.87	0.9 l	Straight	95x10
CEM-2	61	425	650	0.87	0.9 l	Round	Dia. 15
CEM-3	61	425	650	0.87	0.9 l	Straight	85x18

HF-99

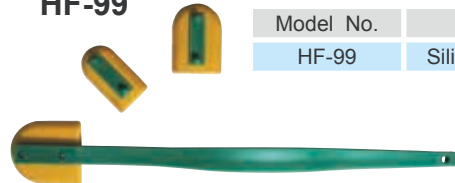

Model No.	Description
HF-99	Silicone Scraper

FISH TAPE SERIES