



novopress

Mastering Innovations

Creating competitive advantages through innovation. That's the key driver for our unique solutions in the electrical industry.

Efficient busbar manufacturing lines and innovative dieless crimping tools, provide the competitive edge for our global customers.

novopress



We are focussed

Novopress is a leading innovator and manufacturer of machines and systems for the electrical industry. Our systems for efficient busbar manufacturing in the switchgear industry, provide the competitive edge for our global customers.

Innovative, dieless crimping technology, ensures the simple and transparent application of Novopress dieless crimping tools in the cable industry.

We not only offer innovative products of high quality standards, we do have solutions for your special applications in electrical engineering.

Our focus - Your benefit

- Redefining busbar manufacturing
- Leveraging 40 years of expertise
- Highest quality results on your products
- Cutting edge precision

Our solution - Your productivity

- Dedicated solutions
- Highly efficient
- Enabling low-cost, high quality production
- More functionalities
- Increasing your output
- Reducing your lead times

Our commitment - Your confidence

- Persistent customer relations
- Global after sales network
- First rate tech - documentation
- Exceptional low downtimes

novopress



Our unique technology for fully automatic spring back compensation on busbar bending processes, keeps our customers flying ahead the competition. Products like the latest BGD-5 digital bending machine, are redefining busbar processing to new levels of productivity.

Novopress dieless crimping tools are making the application of crimping terminals easy, secure and transparent. Independent of any terminals or jointing material, we are focusing on the ideal solution for the operator.

Dedicated Solutions

Focused on applications in the electrical industry, Novopress has more than 40 years of expertise, converted into leading products with key features for the electrical industry.





Three-in-one busbar fabricating SLB 125

The unique SLB 125 three-in-one busbar tool guarantees effortless cutting, bending and punching of copper busbars. Whether in the work shop or at the construction site - the basic unit transforms into a cutting, bending- or punching machine within seconds.

Special accessories also enable cutting - punching - bending of copper flexibars with ease. Our cutting cartridge and special dies, achieve highest standards in quality and safety, when working with flexible busbar.

Busbar fabrication from a single mold:

Precise, simple and quick.

Advantages

- Especially robust and stiff frame.
- Lightning-swift tool changes with a minimum of manipulation.
- Very high quality cutting, bending and punching.
- The 150 bar low-pressure system ensures a long service life and very fast cycle times.
- Busbars bent accurately up to 120° - very accurate reproducibility of the set angle.
- For busbars up to 125 x 13 mm.
- Accessories for flexible busbars available.

Three-in-one busbar fabricating **SLB 125**

Technical Data		Ref. 39659
Height	1,145 mm	
Width	750 mm	
Depth	750 mm	
Weight	180 kg	
Operating Pressure	150 bar (2,200 psi)	
Force	180 kN	
Power rating	0.75 kW	
Voltage	230 V 1-/50 Hz	
Cutting	max. 125 x 13 mm 250 N/mm ²	
Punching	max. ø 6 bis 21 mm	
Bending	max. 125 x 13 mm 250 N/mm ²	



The unique Novopress three-in-one busbar center as a complete set. Cutting - punching - and bending of busbars up to 125 x 13 mm (4" x 1/2") in one compact unit. The SLB 125 Complete System comes ready to operate, including trolley, hydraulic power pack HA 3 and standard accessories.

SLB 125 Accessories

- **Large step bending tool 31646**
For quick and 100 % parallel step bends, on up to 120 x 10 mm busbars.
Step = 37 mm wide and 25 mm high.



- **Small step bending tool 31425**
For quick and 100 % parallel step bends, on up to 80 x 8 mm busbars.
Step = 21 mm wide and 18 mm high.



- **L-bending-tool 31636**
The L-bending-tool will allow short "L"-bends with only 25 mm leg. SLB 125 standard setup will allow 45 mm as shortest leg.



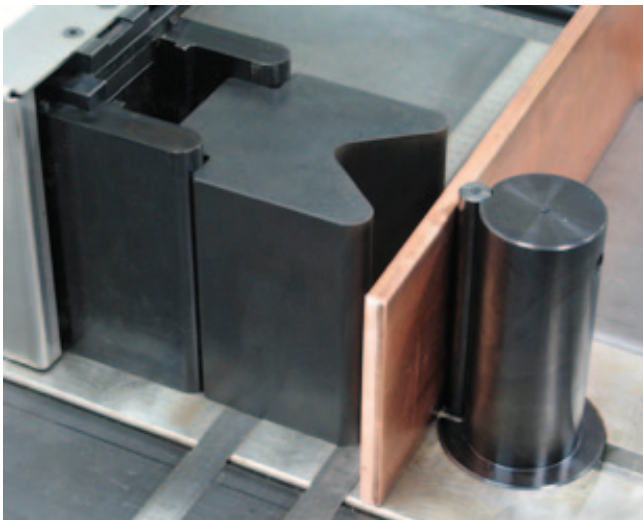

■ **Special U-bender 60 mm 42430**

For accomplishing small and tight U-bends like on no other multi purpose busbar centre.

Min. U-bends are 60 mm (2.4").

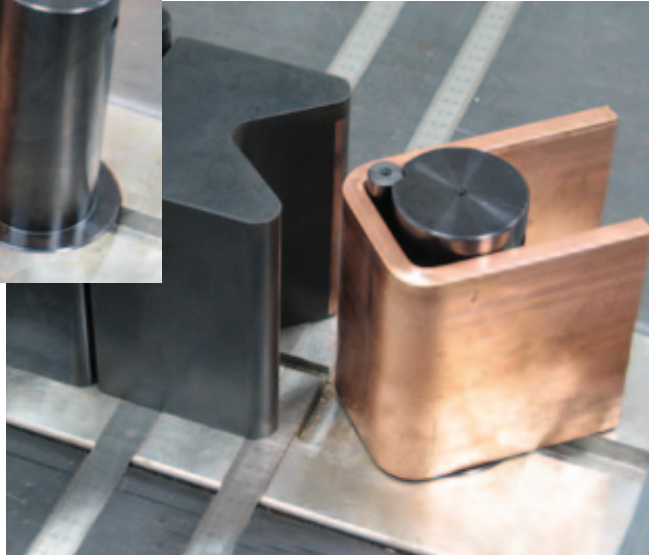

■ **Cutting cartridge 45445**

For cutting flexible copper busbars up to 120 x 10 x 1 mm, our brand new SLB 125 cutting cartridge is available under Ref. 45445.

With this all new cartridge, cutting becomes easy, safe and of outstanding quality. The problematic copper sawing and related dust and chips are a thing of the past. Regardless of cutting insulated or stripped copper bars, subsequent processing will be trouble-free. For punching flexible busbar we recommend using the special punching dies including stripper plate.



HSBL-2 Cutting Tool 120

For stationary and portable cutting applications up to 120 x 13 mm (4" x 1/2"), the HSBL-2 Cutting Tool 120, is the right choice. State of the art operator safety, easy transport and precise cutting with highest quality, are making the HSBL-2 Cutting Tool 120 ideal for small work shops or on site maintenance.



Technical Data Ref. 2350

Height	785 mm (incl. work-cylinder)
Depth	200 mm
Width	210 mm
Weight	12 kg
Operating pressure	150 bar
Force	150 KN
Cutting perf. max.	120 x 13 mm 250 N/mm ²
Cycle time	18 sec.

Recommended power packs: HA 1 - ES, HA 3, HA 4.

Order Numbers

O/N 2350	Cutting tool 120 x 13 mm
O/N 6950	Centering vice for O/N 2350
O/N 6990	Length stop for O/N 2350



HSBL-2 Cutting Tool 120 -
Precise cutting with highest quality.

HSBL-2 Punching Tool 120

For stationary and portable punching applications up to 120 x 13 mm (4" x 1/2"), the HSBL-2 Punching Tool 120, is the right choice. State of the art operator safety, easy transport and excellent punching quality with round, elongated and square dies, are making the HSBL-2 Punching Tool 120 the ideal option for small work shops and on site maintenance.

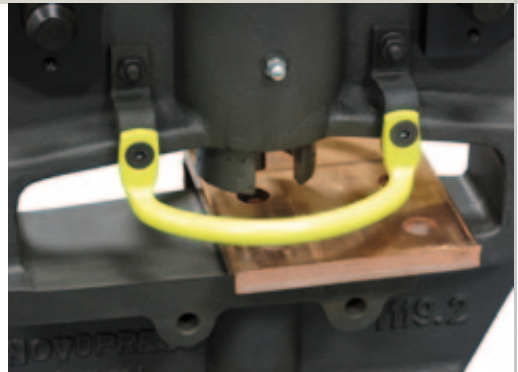
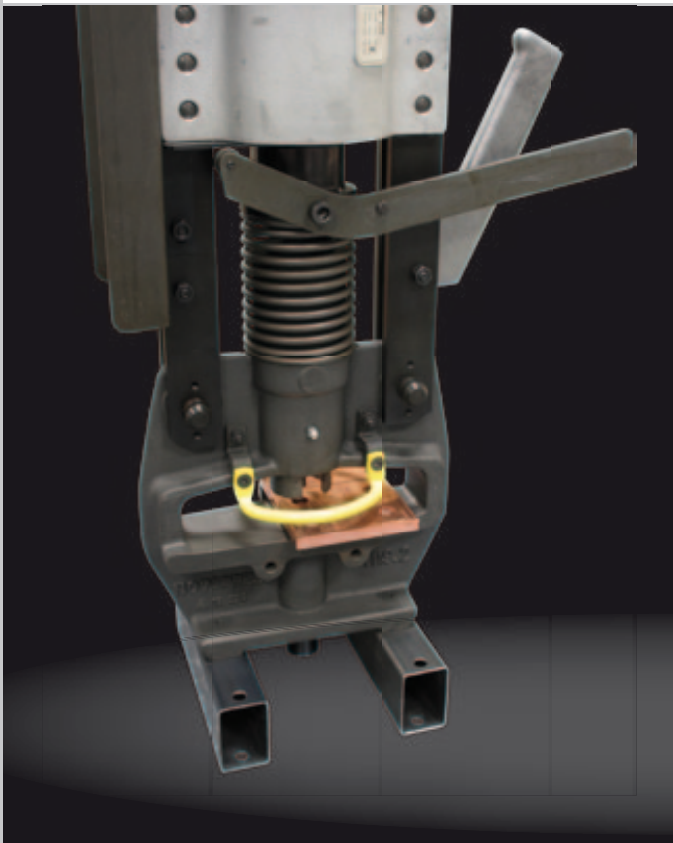

HSBL-2 Punching Tool 120 -
Excellent punching quality with round,
elongated and square dies.

Technical Data Ref. 1118

Height	860 mm (incl. work-cylinder)
Depth	200 mm
Width	260 mm
Weight	15 kg
Operating pressure	150 bar
Force	150 KN
Cutting perf. max.	120 x 13 mm 250 N/mm ²
Cycle time	5.5 sec.*

* Busbar 120 x 10 mm
Power pack HA 3

Order Numbers

O/N 1118	Punching tool 120 x 13 mm
O/N 1179	Bending Tool 120, portable (without image)
O/N 1627	Hydraulic stop valve for O/N 1179 (without image)

We reserve the right to make technical modifications.

novopress

Novopress GmbH & Co. KG
Scharnhorststraße 1 · D-41460 Neuss
Tel.: +49(0)2131-288-0 · Fax: +49(0)2131-288-55
www.novopress.de · E-Mail: verkauf@novopress.de

HSBL-2 Cutting Tool 160

For stationary cutting applications up to 160 x 13 mm (6" x 1/2"), the HSBL-2 Cutting Tool 160, is the ideal choice for professional, stationary busbar production.

State of the art operator safety and additional accessories like centering device and conveyor systems, are making the HSBL-2 Cutting Tool 160, an integrated part of our busbar production lines.

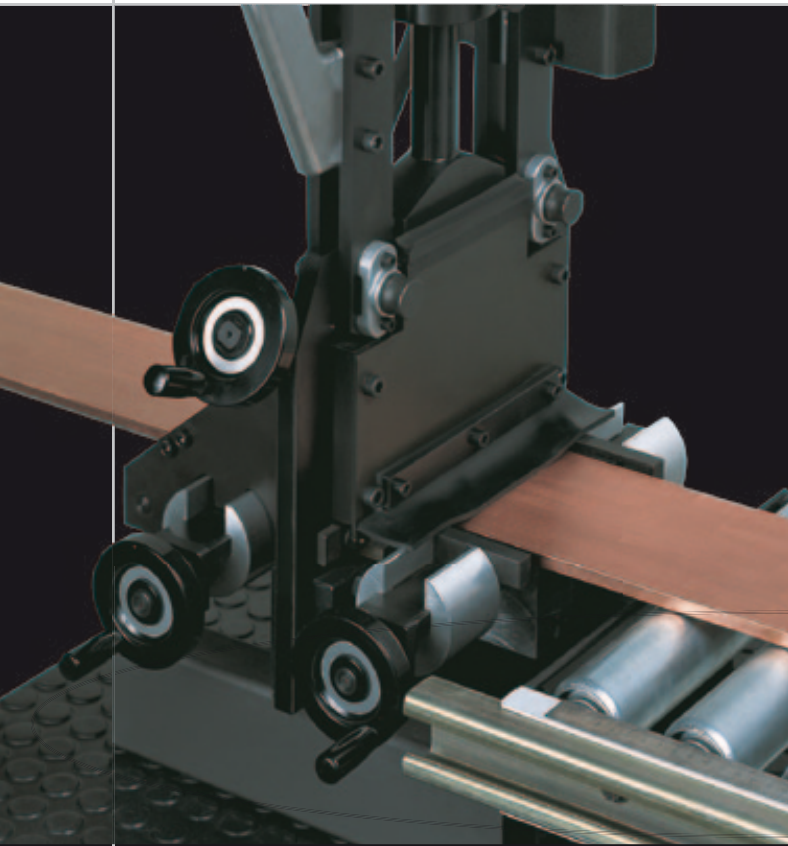

*Picture shows cutting tool 160 x 13 mm (6" x 1/2") including two fixing vices and conveyor.

Technical Data		Ref. 7020
Height	940 mm (incl. work-cylinder)	
Depth	310 mm	
Width	375 mm	
Weight	22 kg	
Operating pressure	150 bar	
Force	150 KN	
Cutting perf. max.	160 x 13 mm 250 N/mm ²	
Cycle time	15 sec.	

Suitable hydraulic power packs, Novopress HA 1 - ES, HA 3, HA 4.

Order Numbers	
O/N 7020	Cutting tool. 160 x 13 mm
O/N 7030	Centering vice for O/N 7020
O/N 6990	Length stop for O/N 7020

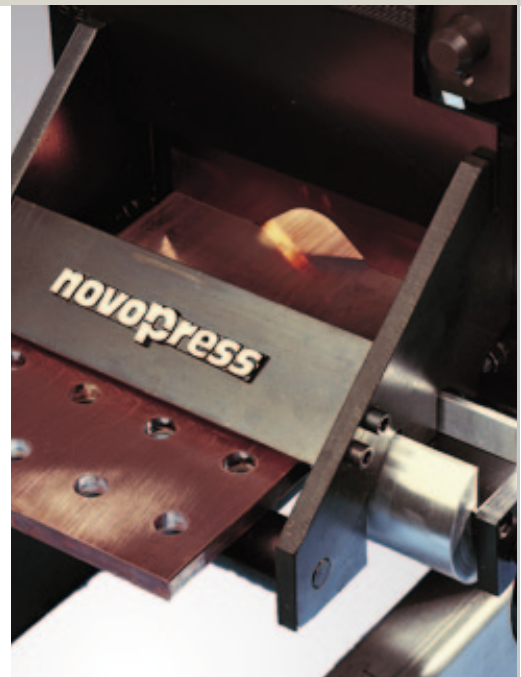

HSBL-2 Cutting Tool 160 x 13 mm (6" x 1/2")

HSBL-2 Punching Tool 160

For stationary punching applications up to 160 x 13 mm (6" x 1/2"), the HSBL-2 Punching Tool 160, is the ideal choice for stationary busbar production. State of the art operator safety and the additional X-Y positioning device will vanquish the need for pre-measuring and center marking on your busbar. Excellent punching quality with round, elongated and square dies, are making the HSBL-2 Cutting Tool 160 the ideal option for small and medium work shops.



Technical Data Ref. 34243

Height	900 mm (incl. work-cylinder)
Depth	460 mm
Width	600 mm
Weight	38.2 kg
Operating pressure	150 bar
Force	150 KN
Cutting perf. max.	160 x 13 mm 250 N/mm ²
Cycle time	5.5 sec.*

* Busbar 120 x 10 mm
Power pack HA 3

Order Numbers

O/N 34243	Punching tool 160 x 13 mm incl. X-Y positioning device
O/N 7050	Punching tool 160 x 13 mm
O/N 7190	X-Y stop device for O/N 7050

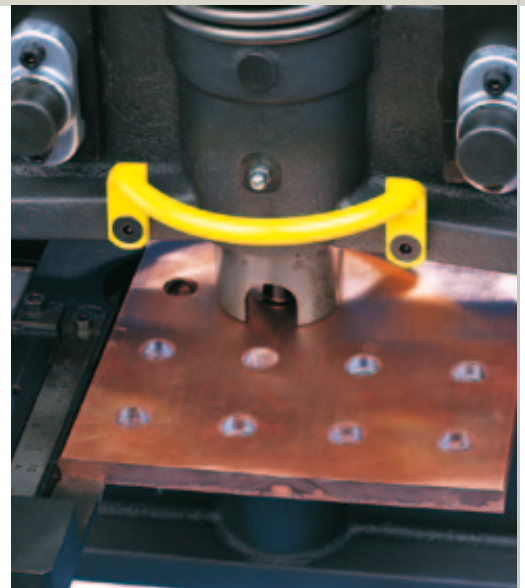

Punching tool 160 x 13 mm (O/N 7050)



A new class of Performance

With the brand-new “DigiPunch 160”, Novopress offers a new class of busbar punching performance for medium-sized enterprises. Wherever ordinary manual punches are insufficient and CNC-controlled machines are too costly, the new “DigiPunch 160” is the ideal mid-size solution. It reduces manufacturing time and cost significantly compared to manual punches at a very modest investment compared to CNC-punches. The very practical configuration with digital metering in X/Y axis and complete conveyors, enables a very efficient and flexible busbar manufacturing.

Advantages

- Significantly reduced manufacturing cost on medium to medium-large output volume.
- Optimized and speedy work flow through integrated conveyor system and work-bench.
- No programming or preparatory work required, very short set-up times.
- Fast and stepless positioning of busbars in X and Y axis, with 0.5 mm accuracy.
- Switching from absolute- to chain-measurement for fast and easy progressive punching.

HSBL-2 DigiPunch 160

All necessary components except hydr. power pack and work cylinder are included in delivery. For operation only a regular 110V/60Hz or 220V/50Hz power source is needed. The LCD measuring system works on a permanent battery basis. Possible hydr. Power Packs: HA 1 - ES, HA 3 and HA 4.

Technical Data		Ref. 40800
Height	1,900 mm	
Length	4,300 mm	
Width	550 mm	
Weight	170 kg	
Operating pressure	150 bar (2,200 psi)	
Force	150 kN	

Ref. Numbers	
Ref. No. 40800	"DigiPunch 160"
Ref. No. 40900	"DigiPunch 160", including hydr. cylinder and Power Pack HA 3

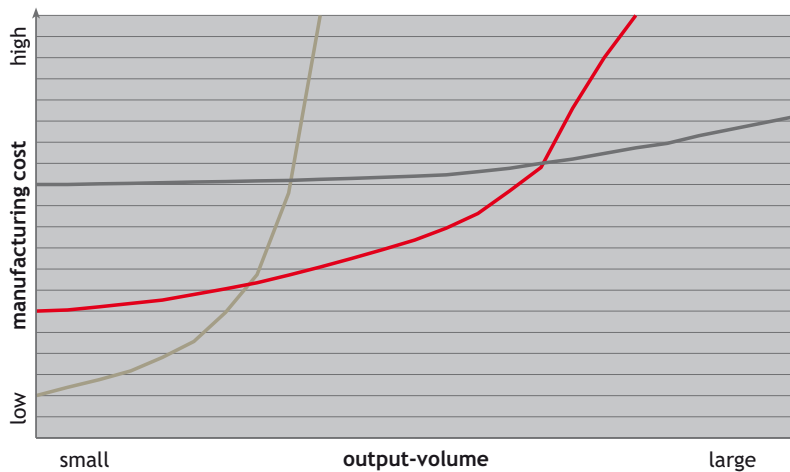

Fast - productive - competitive

- DigiPunch 160
- Manual punching machine
- CNC punching machine

Progressive punching dies

Also the punching dies further reduce manufacturing cost. Punch and die are interchangeable by quick clamp mechanism within 30 sec. The solid toolholder enables progressive punching for oblong and slotted wholes. Switching from absolute to chain-measurement, offers fast progressive punching without extra calculating. Last but not least we offer a wide range of standard dies, especially matched with the needs of the electrical industry.

- Solid toolholder for progressive punching of oblong and slotted wholes.
- Quick clamping offers fast and easy die change in 30 s. Set-up times are reduced, no tools necessary.
- Large assortment of standard dies for round-, oblong- and square punching.



We reserve the right to make technical modifications.

novopress

Novopress GmbH & Co. KG
 Scharnhorststraße 1 · D-41460 Neuss
 Tel.: +49(0)2131-288-0 · Fax: +49(0)2131-288-55
 www.novopress.de · E-Mail: verkauf@novopress.de



The digital bending bench BGD-5

Based on an embedded Windows XP System, the BGD-5 offers incomparable easy WYSIWYG programming, with a full graphical user interface. No CNC, or whatsoever programming skills are requested, even the most complicated busbar figures are edited with the ease of a few clicks. Complete work pieces are displayed on the 12" LCD display, before starting the initial bending operation.

During bending operation the digital angle measurement with full automatic spring back compensation, will ensure outstanding accuracy of ± 0.25 degrees. The automatic length stop, will travel up to 800 mm, positioning your bus bar within seconds and a precision of 0.5 mm. Last but not least, the integrated 3-phase/400 V power pack takes care of convincing cycle times, at only 11.5 sec. for a full 90 degree bend including spring back compensation.

Advantages

- Latest Windows XP technology with 12" LCD display.
- Unmatched, full graphical WYSIWYG programming.
- USB for backups and remote editing.
- Digital angle encoder with precision to ± 0.25 degrees.
- Full automatic spring back compensation.
- No trial bends. No set up times.
- Digital stroke encoder for minimum cycle times.
- Supplied with built in high performance 3-phase power pack.
- Optional step and edge bending tools, for special bending applications.
- Tight L-, U- and Z-bends possible.
- Mobile machine on wheels for ease of use.

novopress

Digital bending bench BGD-5

Technical Data		Ref. 41800
Depth	900 mm	
Width	1,630 mm	
Height	1,530 mm	
Weight	370 kg	
Operating Pressure	200 bar	
Force	180 KN	
Bending capacity max.	160 x 13 mm (6" x 1/2")	
Length stop travel	800 mm	
Bending radius adaptors	7.5, 10, 15 mm	
Power rating	1.2 kW	
Voltage	400 V 3~/50 Hz.	
Oil flow	3.6 l/min.	
Cycle time*	11.5 sec.	
Cycle time** (repeat operation)	9.4 sec.	
Minimum L-Bend	25 mm	
Minimum U-Bend	60 mm	
Minimum Z-Bend	70 mm	

* 90° bend, 120 x 10 mm busbar size, return stroke incl. full automatic spring back compensation.
 ** 90° bend, 120 x 10 mm busbar size repeated operation.

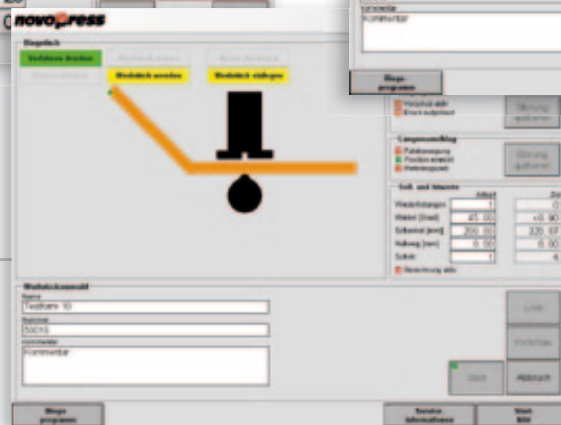

We reserve the right to make technical modifications.

novopress

Novopress GmbH & Co. KG
 Scharnhorststraße 1 · D-41460 Neuss
 Tel.: +49(0)2131-288-0 · Fax: +49(0)2131-288-55
 www.novopress.de · E-Mail: verkauf@novopress.de

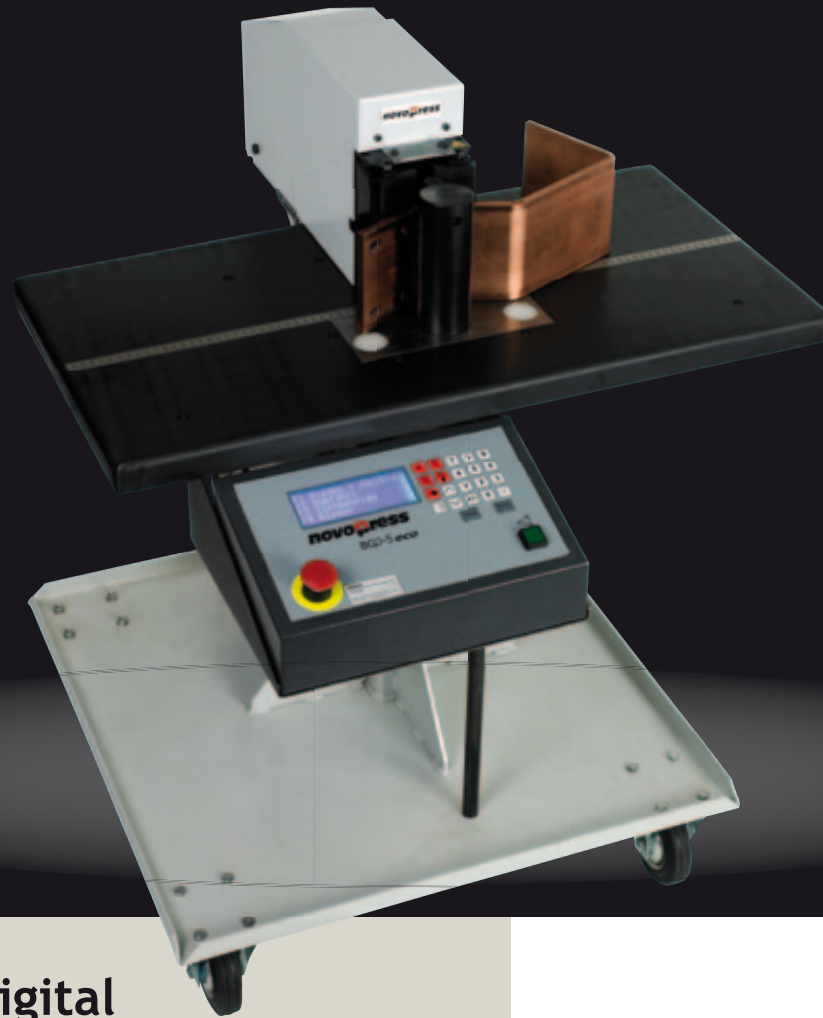

The digital bending bench **BGD-5eco**

The **BGD-5eco** sets a new standard for bus bar bending with outstanding precision and speed at economical prices. No other bending machine will match its range of features and performance at low entry price levels. Equipped with the essential - Digital Angle Encoder - the **BGD-5eco** offers unsurpassed simplicity and control with full automatic spring back compensation and bending accuracy to ± 0.25 degrees. Consequently it will vanquish any need for trial bends and significantly reduce cost on faulty bend busbars. On top, the digital stroke encoder minimizes idle movement for the absolute shortest cycle times. Additional accessories like step or edge benders, are also easy and precisely controlled by the digital stroke encoder.

The new integrated hydraulic power pack takes bending speeds to new levels - 11.5 seconds* - for a finished 90 degree bend including full automatic spring back compensation.

Advantages

- Unsurpassed bending features at economic price.
- Digital Angle Encoder with precision to ± 0.25 degrees.
- Full automatic spring back compensation.
- No trial bends. No set up times.
- Digital Stroke Encoder for minimum cycle times.
- Supplied with built in high performance 3-phase power pack.
- Optional step and edge bending tools, for special bending applications.
- Tight L-, U- and Z-bends possible.
- Mobile machine on wheels for ease of use.

novopress

Digital bending bench **BGD-5eco**

Technical Data	Ref. 42380
Height	1,330 mm
Depth	950 mm
Width	830 mm
Weight	170 kg
Operating Pressure	200 bar
Force	180 kN
Bending capacity max.	160 x 13 mm (6" x 1/2")
Bending radius adaptors	7.5, 10, 15 mm
Power rating	0.75 kW
Voltage	400 V 3~/50 Hz.
Oil flow	3.6 l/min.
Cycle time*	11.5 sec.
Cycle time** (repeat operation)	9.4 sec.
Minimum L-Bend	25 mm
Minimum U-Bend	60 mm
Minimum Z-Bend	70 mm

* 90° bend, 120 x 10 mm busbar size, return stroke incl. full automatic spring back compensation.

** 90° bend, 120 x 10 mm busbar size repeated operation.

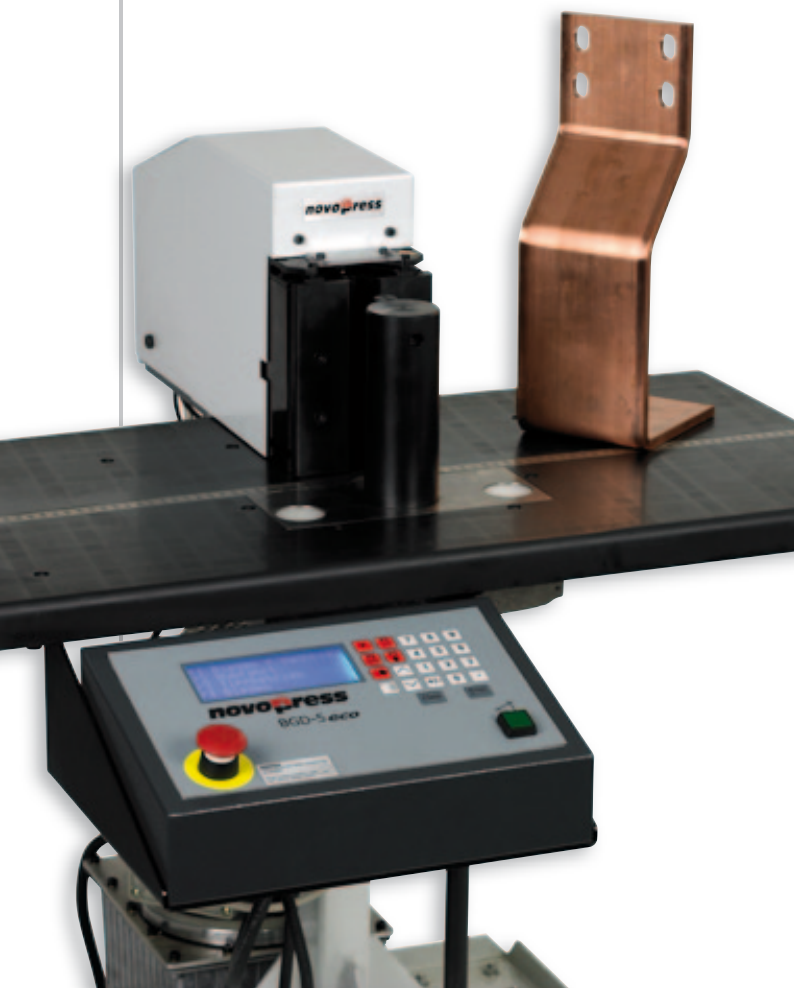

We reserve the right to make technical modifications.

novopress

Novopress GmbH & Co. KG
Scharnhorststraße 1 · D-41460 Neuss
Tel.: +49(0)2131-288-0 · Fax: +49(0)2131-288-55
www.novopress.de · E-Mail: verkauf@novopress.de



The dieless, cordless, stressless crimping tool

With the new HPA 400 Novopress presents a new, battery-operated member of the tried-and-tested HP crimping tool family.

The HPA 400 offers the well established advantages of the dieless Novopress V-Crimp in combination with a state-of-the-art electrohydraulic battery drive. Weighing only 7.5 kg and with sporting exemplary ergonomics, our HPA 400 sets new standards in terms of convenience and safety in it's class. Without changing dies you can crimp various makes of lugs or sleeves from 16 - 400 mm² (AWG 8 - 750 MCM) in Cu and Al quality in only 9 sec. The swivel head allows crimping even in restricted working space.

Advantages

- Integrated crimp control over the whole cross section range for Cu and Al lugs or sleeves.
- Up to 120 compressions per charge.
- No additional cost for die sets.
- Common 14.4 V/2.4 Ah battery from Atlas Copco or Milwaukee respectively.
- Battery indicator prevents incomplete compressions.

novopress

Dieless crimping tool **HPA 400**

Cost-effective, fast and all-purpose

Attributes of the Novopress V-Crimp for decades, which are now also available in a cordless power crimping tool. The integrated "smart-crimp" system ensures a consistent quality of compression over the whole cross section range from 16 - 400 mm² (AWG 8 - 750 MCM).

Time consuming and expensive die sets are unnecessary with the Novopress crimp system and will no longer be a source of confusion for the operator. Lugs or sleeves, copper or aluminium, stranded or flexible cable, you never have to worry about choosing the right die.

Technical Data		Ref. 38500
Length	470 mm	
Weight	7.5 kg	
Cross section range Cu	16 - 400 mm ²	
Cross section range Al	25 - 400 mm ²	
Battery	14.4 V / 2.4 Ah	
Charger	all common Voltages	
Cycle time	9 - 22 sec.	
Crimps per charge	up to 120	

Order Numbers	
O/N 38500	Complete set, incl. case, charger and spare battery



The tried-and-tested Novopress V-Press-System allows "dieless" crimping from 16 - 400 mm² (AWG 8 - 750 MCM).



The HPA 400 kit, incl. case, charger and spare battery.

We reserve the right to make technical modifications.

novopress

Novopress GmbH & Co. KG
Scharnhorststraße 1 · D-41460 Neuss
Tel.: +49(0)2131-288-0 · Fax: +49(0)2131-288-55
www.novopress.de · E-Mail: verkauf@novopress.de

Selfcontained Crimping Head HPM 400

Dieless, stressless, universal.

The HPM 400 from Novopress is the ultimate Crimping Tool for service and maintenance jobs. The totally maintenance-free, self-contained hydraulic system guarantees persistent operational condition, even beyond any infrastructure. The universal crimping head is without any die change whatsoever, over the whole cross section range from 16 - 400 mm². It will eliminate any additional cost for die sets and time consuming changes thereof. The smart automatic compression secures constant high quality of your crimps over the whole cross section range.



Technical Data		Ref. 5200
Length	550 mm	
Width	180 mm	
Height	80 mm	
Weight	5.9 kg	
Cross section range Cu	16 - 400 mm ²	
Cross section range Al	50 - 400 mm ²	
Max. Force	110 kN	
Max. lug dia.	38.5 mm	

Order Numbers	
O/N 5200	Complete set, incl. box and test bar.

The smart dieless system, developed and patented by Novopress, enables high quality crimps for various makes of cable lugs and sleeves without changing any dies. The HP-Series ensures continual operational readiness, safety and efficiency on crimps with various cross sections in random order. Compressions will comply with VDE-Standard 0220, NF C 63-061 and SEN 245012.

Dieless Crimping Head HPH 400

Dieless, stressless, universal.

The HPH 400 from Novopress, is designed for usage with customary 700 bar (10.000 psi) hydraulic power packs. Optimal crimping control is provided with the genuine Novopress HA11 power pack, offering full automatic crimp control and latest safety features. Extremely short cycle times and the dieless crimping technology, will make each HP crimping head the ideal production tool. The smart dieless system secures a constant quality crimp throughout the cross section range. Changing dies is obsolete throughout the cross section range from 16 - 400 mm². Within seconds, various makes of cable lugs or sleeves from Cu or Al, will be crimped with perfection.



Technical Data		Ref. 41525
Length	380 mm	
Weight	4 kg	
Operating Pressure	700 bar	
Cross section range Cu	16 - 400 mm ²	
Diameter	65 mm	
Max. Force	110 kN	
Max. lug dia.	38.5 mm	

Suitable hydraulic power packs, Novopress HA 11 (Ref. 40123).

Order Numbers	
O/N 41525	Remote Crimping Head incl. test bar.



The smart dieless system, developed and patented by Novopress, enables high quality crimps for various makes of cable lugs and sleeves without changing any dies. The HP-Series ensures continual operational readiness, safety and efficiency on crimps with various cross sections in random order. Compressions will comply with VDE-Standard 0220, NF C 63-061 and SEN 245012.

Dieless Crimping Head HP 95

Dieless, stressless, universal.

Crimping heads of the Novopress HP-Series, are primarily used in a production- or workshop-environment. Extremely short cycle times, highest safety standards and the dieless crimping technology, will make each HP crimping head the ideal production tool. The smart dieless system secures a constant quality crimp throughout the cross section range. Changing dies is obsolete throughout the cross section range from 10 - 95 mm². Within 3 seconds only, various makes of cable lugs or sleeves from Cu or Al, will be crimped with perfection.

Technical Data		Ref. 3000
Length	350 mm	
Weight	3 kg	
Operating Pressure	150 bar	
Max. Force	55 kN	
Cross section range Cu	10 - 95 mm ²	
Diameter	65 mm	
Max. diameter (insertion)	20 mm	

Suitable hydraulic power packs, Novopress HA 1 - ES or HA 3.
We recommend HA 1 - ES (Ref. 31070)

Order Numbers

O/N 3000	HP 95 Remote head, incl. test bar.
----------	------------------------------------



The smart dieless system, developed and patented by Novopress, enables high quality crimps for various makes of cable lugs and sleeves without changing any dies. The HP-Series ensures continual operational readiness, safety and efficiency on crimps with various cross sections in random order. Compressions will comply with VDE-Standard 0220, NF C 63-061 and SEN 245012.

Dieless Crimping Head HP 300

Dieless, stressless, universal.

Crimping heads of the Novopress HP-Series, are primarily used in a production- or workshop-environment. Extremely short cycle times, highest safety standards and the dieless crimping technology, will make each HP crimping head the ideal production tool. The smart dieless system secures a constant quality crimp throughout the cross section range. Changing dies is obsolete throughout the cross section range from 50 - 300 mm². Within 3 seconds only, various makes of cable lugs or sleeves from Cu or Al, will be crimped with perfection.



Technical Data		Ref. 1000
Length	430 mm	
Weight	4.5 kg	
Operating Pressure	150 bar	
Max. Force	100 kN	
Cross section range Cu	50 - 300 mm ²	
Diameter	80 mm	
Max. diameter (insertion)	34 mm	

Suitable hydraulic power packs, Novopress HA 1 - ES or HA 3.
We recommend HA 1 - ES (Ref. 31070)

Order Numbers	
O/N 1000	HP 300 Remote head, incl. test bar.



The smart dieless system, developed and patented by Novopress, enables high quality crimps for various makes of cable lugs and sleeves without changing any dies. The HP-Series ensures continual operational readiness, safety and efficiency on crimps with various cross sections in random order. Compressions will comply with VDE-Standard 0220, NF C 63-061 and SEN 245012.

Hydraulic Power Pack HA 1 - ES

Leaders when it comes to switchgear manufacturing. Novopress hydraulic power packs are designed to operate at a low 150 bar over a wide range of applications. This design combines the clear advantages of increased work safety and long service life for the tool and its attached devices. In addition, these hydraulic power packs are a byword for the high quality associated with all Novopress products.



Technical Data		Ref. 31070
Drive	230 V - 800 W, 4 A	
Weight	15.5 kg	
Height	470 mm	
Width	270 mm	
Oil capacity	3.5 l	
Operation S 3	25 %, 100 s	
Safety class	IP 44	
Hydraulic hose	2.5 m	
Operating pressure	150 bar (2,200 psi)	
Oil flow	4.5 l/min.	

Order Numbers

O/N 31070 Power Pack HA 1 - ES

For all applications on site and regular workload in fabricating the HA 1 - ES is our standard power pack. Through a combined safety and return valve, an overload of either the power pack or the connected tool is prevented.

User friendly operation by foot-switch with integrated emergency button and integrated 24 V controls for hand operated tools meets the latest safety regulation VVA/UVB. Complies with VDE regulation 0740.

Hydraulic Power Pack HA 3

Leaders when it comes to switchgear manufacturing. Novopress hydraulic power packs are designed to operate at a low 150 bar over a wide range of applications. This design combines the clear advantages of increased work safety and long service life for the tool and its attached devices. In addition, these hydraulic power packs are a byword for the high quality associated with all Novopress products.



Technical Data		Ref. 32530
Drive	230 V - 750 W, 4 A	
Weight	26 kg	
Height	550 mm	
Length	270 mm	
Width	260 mm	
Oil capacity	5.5 l	
Operation S 3	S 1=	
Safety class	IP 55	
Hydraulic hose	2.5 m	
Operating pressure	150 bar (2,200 psi)	
Oil flow	4.0 l/min.	

Order Numbers	
O/N 32530	Power Pack HA 3
O/N 33340	Power Pack HA 3 incl. 24 V controls

For heavy duty applications and continuous production, the HA 3 Power Pack is the professional choice.

With a high performance drive and extended oil volume, the HA 3 is the ideal power pack for demanding busbar production and/or continuous cable assembly. Available with or without 24 V controls for hand operated crimping tools.

Hydraulic Power Pack HA 4

Leaders when it comes to switchgear manufacturing. Novopress hydraulic power packs are designed to operate at a low 150 bar over a wide range of applications. This design combines the clear advantages of increased work safety and long service life for the tool and its attached devices. In addition, these hydraulic power packs are a byword for the high quality associated with all Novopress products.



Technical Data Ref. 42780

Drive	400 V/50 Hz 3P +N
Weight incl. Oil	45 kg
Height	560 mm
Length	470 mm
Width	420 mm
Oil capacity	12 l
Operation S 3	S 1=
Protection class	IP 55
Hydraulic hose	2.5 m
Operating pressure	150 bar (2,200 psi)
Oil flow	9 l/min.

Order Numbers

O/N 42780	Power Pack HA 4
-----------	-----------------

The HA 4 presents our power house for very demanding busbar production. With an Oil flow rate of 9 l/min. the HA 4 will reduce cutting or punching cycles by 50 %, compared to HA 1 - ES or HA 3 models.

Thus it is the perfect choice for medium to large switchgear manufacturers, looking for a high output in their busbar production.

The HA 4 is not suitable for mobile applications or dieless crimping tools.

High pressure Power Pack HA 11

The HPH 400 Special.

Especially designed for the dieless HPH 400 crimping tool, this power pack is the ideal power source at 700 bar (10,000 psi) operating pressure. A combined safety and return valve prevents overloading of the unit and any attached tools.



Technical Data Ref. 40123

Drive	230 V - 370 W, 2 A
Weight incl. Oil	18 kg
Height	440 mm
Width	160 mm
Oil capacity	2.5 l
Operation S 3	25 %, 100 s
Protection class	IP 55
Hydraulic hose	2.5 m
Operating pressure	700 bar (10,000 psi)
Oil flow	4.0 l/min.

Order Numbers

O/N 40123	Power Pack HA 11
-----------	------------------



Dieless Crimping
Head HPH 400

The HA 11 power pack is suitable for high pressure 700 bar (10,000 psi) hydraulic tools only. In particular the HEX 300-10 and HPH 400 crimping heads. For any other brand, please check technical specifications of the attached tool.

novopress

Novopress GmbH & Co. KG
Scharnhorststraße 1 · D-41460 Neuss
Tel.: +49 (0) 2131-288-0 · Fax: +49 (0) 2131-288-55
www.novopress.com · E-Mail: verkauf@novopress.de

novopress